



## INSTRUCTION MANUAL

VHF MARINE TRANSCEIVER

# IC-M25 IC-M25EURO

This device complies with Part 15 of the FCC Rules. Operation is subject to the condition that this device does not cause harmful interference.



IC-M25

IC-M25EURO

Icom Inc.

---

## FOREWORD

---

Thank you for choosing this Icom product. The IC-M25/IC-M25EURO VHF MARINE TRANSCEIVER is designed and built with Icom's state of the art technology and craftsmanship. With proper care, this product should provide you with years of trouble-free operation.

---

## IMPORTANT

---

**READ ALL INSTRUCTIONS** carefully and completely before using the transceiver.

**SAVE THIS INSTRUCTION MANUAL**—This instruction manual contains important operating instructions for the IC-M25/IC-M25EURO.

---

## EXPLICIT DEFINITIONS

---

WORD	DEFINITION
⚠ <b>DANGER!</b>	Personal death, serious injury or an explosion may occur.
⚠ <b>WARNING!</b>	Personal injury, fire hazard or electric shock may occur.
<b>CAUTION</b>	Equipment damage may occur.
<b>NOTE</b>	If disregarded, only inconvenience. No risk of personal injury, fire or electric shock.

---

## FEATURES

---

### 👁️ **Floats on water**

The transceiver floats in fresh or salt water even when the supplied accessories are attached.

- It may sink when a third-party accessory is attached.

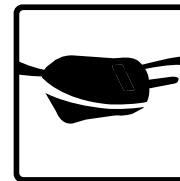

### 👁️ **Floats and flashes**

An LED sends out intermittent light from a transparent section on the bottom of the transceiver, while floating in the water.

As the LED light stands out in the dark, the transceiver can be easily retrieved from the water.

This function works even when the transceiver is turned OFF.

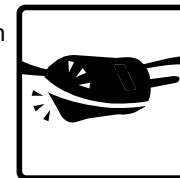

### 👁️ **Floats and flashes alarm**

An alarm sounds when the transceiver is dropped into the water so that you can know that the transceiver has fallen in the water.



---

## IN CASE OF EMERGENCY

---

If your vessel requires assistance, contact other vessels and the appropriate Coast Guard by sending a distress call on Channel 16.

○ **USING CHANNEL 16**

### **DISTRESS CALL PROCEDURE**

1. "MAYDAY MAYDAY MAYDAY."
2. "THIS IS ..... " (name of vessel)
3. Your call sign or other identification of the vessel.
4. "LOCATED AT ..... " (your position)
5. The nature of the distress and assistance required.
6. Any other information which might facilitate the rescue.

---

## RECOMMENDATION

---

**CLEAN THE TRANSCEIVER THOROUGHLY WITH FRESH WATER** after exposure to saltwater, and dry it before operating. Otherwise, the transceiver's keys, switches and controllers may become unusable due to salt crystallization.

**NOTE:**

**DO NOT** wash the transceiver in water if there is any reason to suspect the waterproofing may not be effective. For example, in cases where the transceiver/jack cap/connector cover is cracked or broken, or the transceiver has been dropped.



---

# RADIO OPERATOR WARNING

---



## WARNING

Your Icom radio generates RF electromagnetic energy during transmit mode. This radio is designed for and classified as “General Population Use” in an uncontrolled environment.

This radio has been evaluated for compliance at the distance of 2.5 cm (1 inch) with the FCC and IC RF exposure limits for “General Population Use.” In addition, your Icom radio complies with the following Standards and Guidelines with regard to RF energy and electromagnetic energy levels and evaluation of such levels for exposure to humans:

- FCC OET Bulletin 65 Edition 01-01 Supplement C, Evaluating Compliance with FCC Guidelines for Human Exposure to Radio Frequency Electromagnetic Fields.
- American National Standards Institute (C95.1-1992), IEEE Standard for Safety Levels with Respect to Human Exposure to Radio Frequency Electromagnetic Fields, 3 kHz to 300 GHz.
- American National Standards Institute (C95.3-1992), IEEE Recommended Practice for the Measurement of Potentially Hazardous Electromagnetic Fields— RF and Microwave.
- The following accessories are authorized for use with this product. Use of accessories other than those specified may result in RF exposure levels exceeding the FCC and IC requirements for wireless RF exposure.: Belt Clip (MB-133).



## CAUTION

To ensure that your expose to RF electromagnetic energy is within the FCC and IC allowable limits for general population use, always adhere to the following guidelines:

- **DO NOT** operate the radio without a proper antenna attached, as this may damaged the radio and may also cause you to exceed FCC and IC RF exposure limits. A proper antenna is the antenna supplied with this radio by the manufacturer or antenna specifically authorized by the manufacturer for use with this radio.
- **DO NOT** transmit for more than 50% of total radio use time (“50% duty cycle”). Transmitting more than 50% of the time can cause FCC and IC RF exposure compliance requirements to be exceeded. The radio is transmitting when the “transmit indicator” appears on the LCD. You can cause the radio to transmit by pressing the “PTT” switch.
- **ALWAYS keep** the antenna at least 2.5 cm (1 inch) away from the body when transmitting and only use the Icom belt clip which is listed on page 30 when attaching the radio to your belt, etc., to ensure FCC and IC RF exposure compliance requirements are not exceeded. To provide the recipients of your transmission the best sound quality, hold the antenna at least 5 cm (2 inches) from your mouth, and slightly off to one side.

The information listed above provides the user with the information needed to make him or her aware of RF exposure, and what to do to assure that this radio operates with the FCC and IC RF exposure limits of this radio.

## Electromagnetic Interference/Compatibility

During transmissions, your Icom radio generates RF energy that can possibly cause interference with other devices or systems. To avoid such interference, turn off the radio in areas where signs are posted to do so. **DO NOT** operate the transmitter in areas that are sensitive to electromagnetic radiation such as hospitals, aircraft, and blasting sites.

---

# AVERTISSEMENT POUR LES OPÉRATEURS RADIO

---



## AVERTISSEMENT

Votre radio Icom produit une énergie électromagnétique de radiofréquences (RF), en mode de transmission. Elle est conçue pour une «utilisation grand public», dans un environnement non contrôlé. Cet appareil a été évalué et jugé conforme, à 2,5 cm, aux limites d'exposition aux RF de la FCC et d'IC, pour une «utilisation grand public». En outre, votre radio Icom satisfait les normes et directives qui suivent en matière de niveaux d'énergie et d'énergie électromagnétique de RF et d'évaluation de tels niveaux en ce qui concerne l'exposition humaine :

- Supplément C, édition 01-01, du Bulletin OET de la FCC, «Evaluating Compliance with FCC Guidelines for Human Exposure to Radio Frequency Electromagnetic Fields».
- Norme de l'American National Standards Institute (ANSI) : IEEE C95.1-1992 sur les niveaux de sécurité compatibles avec l'exposition humaine aux champs électromagnétiques de radiofréquences (3 kHz à 300 GHz).
- Norme de l'ANSI : IEEE C95.3-1992 sur la méthode d'évaluation recommandée du champ magnétique potentiellement dangereux des radiofréquences et des micro-ondes.
- Les accessoires qui suivent sont approuvés pour une utilisation avec ce produit. L'utilisation d'accessoires autres que ceux précisés peut entraîner des niveaux d'exposition aux RF supérieures aux limites établies par la FCC et d'IC en matière d'exposition aux RF sans fil; attache pour ceinture (MB-133).



## MISE EN GARDE

### CAUTION

**Afin de vous assurer que votre exposition à une énergie électromagnétique de RF se situe dans les limites permises par la FCC et d'IC pour une utilisation grand public, veuillez en tout temps respecter les directives suivantes :**

- **NE PAS** faire fonctionner la radio sans qu'une antenne appropriée y soit fixée, car ceci risque d'endommager la radio et causer une exposition supérieure aux limites établies par la FCC et d'IC. L'antenne appropriée est celle qui est fournie avec cette radio par le fabricant ou une antenne spécialement autorisée par le fabricant pour être utilisée avec cette radio.
- **NE PAS** émettre pendant plus de 50% du temps total d'utilisation de l'appareil («50% du facteur d'utilisation»). Émettre pendant plus de 50% du temps total d'utilisation peut causer une exposition aux RF supérieure aux limites établies par la FCC et d'IC. La radio est en train d'émettre lorsque le témoin du mode de transmission s'affiche sur l'écran ACL. La radio émettra si vous appuyez sur le bouton du microphone.
- **TOUJOURS** tenir l'antenne éloignée d'au moins 2,5 cm de votre corps au moment d'émettre et utiliser uniquement l'attache pour ceinture Icom illustrée à la p. 30, lorsque vous attachez la radio à votre ceinture, ou à autre chose, de façon à vous assurer de ne pas provoquer une exposition aux RF supérieure aux limites fixées par la FCC et d'IC. Pour offrir à vos interlocuteurs la meilleure qualité de transmission possible, tenez l'antenne à au moins 5 cm de votre bouche et légèrement de côté.

Les renseignements ci-dessus fournissent à l'utilisateur toute l'information nécessaire sur l'exposition aux RF et sur ce qu'il faut faire pour assurer que cette radio fonctionne en respectant les limites d'exposition aux RF établies par la FCC et d'IC.

### Interférence électromagnétique et compatibilité

En mode de transmission, votre radio Icom produit de l'énergie de RF qui peut provoquer des interférences avec d'autres appareils ou systèmes. Pour éviter de telles interférences, mettez la radio hors tension dans les secteurs où une signalisation l'exige. **NE PAS** faire fonctionner l'émetteur dans des secteurs sensibles au rayonnement électromagnétique tels que les hôpitaux, les aéronefs et les sites de dynamitage.

---

## PRECAUTIONS

---

**⚠ WARNING! NEVER** connect the radio to an AC outlet. This may pose a fire hazard or result in an electric shock.

**⚠ WARNING! NEVER** hold the radio so that the antenna is closer than 2.5 cm (1 inch) from exposed parts of the body, especially the face or eyes, while transmitting. The radio will perform best if the microphone is 5 to 10 cm (2 to 4 inches) away from the lips and the radio is vertical.

**CAUTION: NEVER** connect the radio to a power source other than the products specified by Icom. Such a connection will ruin the radio.

**CAUTION: MAKE SURE** the antenna is securely attached to the radio, and that the antenna is dry before attachment. Exposing the inside of the radio to water will result in serious damage to the radio.

**BE CAREFUL:** The radio meets IPX7 requirements for waterproof protection. However, once the radio has been dropped, waterproof protection cannot be guaranteed because of possible damage to the radio's case or the waterproof seal.

**DO NOT** use harsh solvents such as benzine or alcohol when cleaning, as they will damage the radio surfaces.

**DO NOT** push [PTT] when not actually intending to transmit.

**DO NOT** modify the radio. The radio warranty does not cover any problems caused by unauthorized modification.

**DO NOT** operate the radio near unshielded electrical blasting caps or in an explosive atmosphere.

**DO NOT** use or place the radio in direct sunlight or in areas with following temperatures range.

- For the USA and EXP versions:  
Below  $-20^{\circ}\text{C}$  ( $-4^{\circ}\text{F}$ ) or above  $+60^{\circ}\text{C}$  ( $+140^{\circ}\text{F}$ )
- For the EUR, FRG, HOL, UK, and CHN versions:  
Below  $-15^{\circ}\text{C}$  ( $+5^{\circ}\text{F}$ ) or above  $+55^{\circ}\text{C}$  ( $+131^{\circ}\text{F}$ )
- For the AUS version:  
Below  $-10^{\circ}\text{C}$  ( $+14^{\circ}\text{F}$ ) or above  $+55^{\circ}\text{C}$  ( $+131^{\circ}\text{F}$ )

**KEEP** the radio out of the reach of children.

**KEEP** the radio at least 0.9 meter (3.0 feet) away from your vessel's magnetic navigation compass.

**MAKE SURE** the antenna and battery cover are securely attached to the transceiver, and that the antenna and battery cover are dry before attachment. Exposing the inside of the transceiver to water will result in serious damage to the transceiver.

### Information:

In this instruction manual, the country names are described as shown below.

U.S.A.: USA	Export: EXP	Europe: EUR
German: FRG	Dutch: HOL	U.K.: UK
China: CHN	Australia: AUS	

Icom, Icom Inc. and Icom logo are registered trademarks of Icom Incorporated (Japan) in Japan, the United States, the United Kingdom, Germany, France, Spain, Russia, Australia, New Zealand, and/or other countries.

---

# TABLE OF CONTENTS

---

FOREWORD .....	i	■ Volume Loud function .....	12
IMPORTANT .....	i	■ Volume Mute function .....	12
EXPLICIT DEFINITIONS .....	i	■ Lock function .....	12
FEATURES .....	i	■ AquaQuake Water Draining function .....	13
IN CASE OF EMERGENCY .....	ii	■ Setting the Call channel .....	13
RECOMMENDATION .....	ii	<b>5 SCAN OPERATION (All except the HOL version) .....</b>	<b>14–15</b>
RADIO OPERATOR WARNING .....	iii	■ Scan types .....	14
AVERTISSEMENT POUR LES OPÉRATEURS RADIO .....	iv	■ Setting Favorite channels .....	15
PRECAUTIONS .....	v	■ Starting a scan .....	15
TABLE OF CONTENTS .....	vi	<b>6 DUALWATCH AND TRI-WATCH .....</b>	<b>16</b>
FCC INFORMATION .....	vii	■ Description .....	16
DISPOSAL .....	vii	■ Operation .....	16
COUNTRY CODE LIST .....	vii	<b>7 SET MODE .....</b>	<b>17–21</b>
<b>1 OPERATING RULES .....</b>	<b>1</b>	■ Set mode entry .....	17
<b>2 ACCESSORIES ATTACHMENTS .....</b>	<b>2–3</b>	■ Set mode items .....	18
■ Supplied accessories .....	2	<b>8 ABOUT THE BATTERY .....</b>	<b>22–24</b>
■ Attachments .....	2	■ Battery caution .....	22
■ Charging .....	3	<b>9 OPTIONAL SPEAKER-MICROPHONE (HM-213) .....</b>	<b>25</b>
<b>3 PANEL DESCRIPTION .....</b>	<b>4–7</b>	■ Descriptions .....	25
■ Front, top and side panels .....	4	■ Attaching .....	25
■ Function Display .....	6	<b>10 ATIS CODE (For only the HOL and FRG versions) .....</b>	<b>26</b>
<b>4 BASIC OPERATION .....</b>	<b>8–13</b>	<b>11 TROUBLESHOOTING .....</b>	<b>27</b>
■ Selecting a channel .....	8	<b>12 SPECIFICATIONS AND OPTIONS .....</b>	<b>28–30</b>
■ Receiving and transmitting .....	10	■ Specifications .....	28
■ Adjusting the volume level .....	10	■ Options .....	30
■ Adjusting the squelch level .....	11	<b>13 VHF MARINE CHANNEL LIST .....</b>	<b>31–33</b>
■ Monitor function .....	11	<b>INDEX .....</b>	<b>34–35</b>
■ Toggling the transmit power .....	11		

---

## FCC INFORMATION

---

### FOR CLASS A UNINTENTIONAL RADIATORS

This equipment has been tested and found to comply with the limits for a Class A digital device, pursuant to part 15 of the FCC Rules. These limits are designed to provide reasonable protection against harmful interference when the equipment is operated in a commercial environment. This equipment generates, uses, and can radiate radio frequency energy and, if not installed and used in accordance with the instruction manual, may cause harmful interference to radio communications. Operation of this equipment in a residential area is likely to cause harmful interference in which case the user will be required to correct the interference at his own expense.

**CAUTION:** Changes or modifications to this device, not expressly approved by Icom Inc., could void your authority to operate this device under FCC regulations.

---

## DISPOSAL

---



The crossed-out wheeled-bin symbol on your product, literature, or packaging reminds you that in the European Union, all electrical and electronic products, batteries, and accumulators (rechargeable batteries) must be taken to designated collection locations at the end of their working life. Do not dispose of these products as unsorted municipal waste. Dispose of them according to the laws in your area.

---

## COUNTRY CODE LIST

---

### • ISO 3166-1

	Country	Codes		Country	Codes
1	Austria	AT	18	Liechtenstein	LI
2	Belgium	BE	19	Lithuania	LT
3	Bulgaria	BG	20	Luxembourg	LU
4	Croatia	HR	21	Malta	MT
5	Czech Republic	CZ	22	Netherlands	NL
6	Cyprus	CY	23	Norway	NO
7	Denmark	DK	24	Poland	PL
8	Estonia	EE	25	Portugal	PT
9	Finland	FI	26	Romania	RO
10	France	FR	27	Slovakia	SK
11	Germany	DE	28	Slovenia	SI
12	Greece	GR	29	Spain	ES
13	Hungary	HU	30	Sweden	SE
14	Iceland	IS	31	Switzerland	CH
15	Ireland	IE	32	Turkey	TR
16	Italy	IT	33	United Kingdom	GB
17	Latvia	LV			



## ◇ Priorities

- Read all rules and regulations pertaining to call priorities, and keep an up-to-date copy handy. Safety and distress calls take priority over all others.
- You must monitor Channel 16 when you are not operating on another channel.
- False or fraudulent distress calls are prohibited under law.

## ◇ Privacy

- Information overheard, but not intended for you, cannot lawfully be used in any way.
- Indecent or profane language is prohibited.

## ◇ Radio licenses

### (1) SHIP STATION LICENSE

You may require a current radio station license before using the transceiver. It is unlawful to operate a ship station which is not licensed, but required to be.

If required, contact your dealer or the appropriate government agency for a Ship-Radiotelephone license application. This government-issued license states the call sign which is your craft's identification for radio purposes.

### (2) OPERATOR'S LICENSE

A Restricted Radiotelephone Operator Permit is the license most often held by small vessel radio operators when a radio is not required for safety purposes.

If required, the Restricted Radiotelephone Operator Permit must be posted or kept with the operator. If required, only a licensed radio operator may operate a transceiver.

However, non-licensed individuals may talk over a transceiver if a licensed operator starts, supervises, ends the call and makes the necessary log entries.

A current copy of the applicable government rules and regulations is only required to be on hand for vessels in which a radio telephone is compulsory. However, even if you are not required to have these on hand it is your responsibility to be thoroughly acquainted with all pertinent rules and regulations.

**NOTE:** Even though the IC-M25/IC-M25EURO is capable of operation on VHF marine channels 3, 21, 23, 61, 64, 81, 82 and 83, according to FCC regulations these simplex channels cannot be lawfully used by the general population in USA waters.

## ■ Supplied accessories

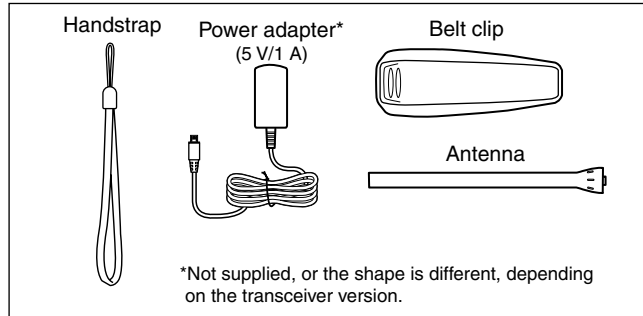

## ■ Attachments

### □ Antenna

Connect the supplied antenna to the antenna connector.

#### CAUTION:

- **NEVER** carry the transceiver by holding just the antenna.
- Transmitting without an antenna can damage the transceiver.

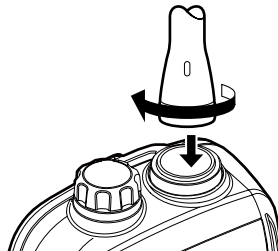

### □ Handstrap

Pass the handstrap through the loop on the back side of the transceiver to make it easy to carry.

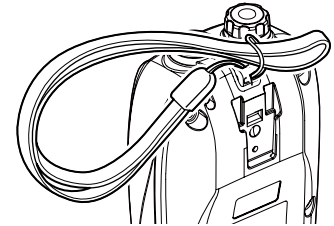

### □ Belt clip

Attach or detach the belt clip.

To attach the belt clip

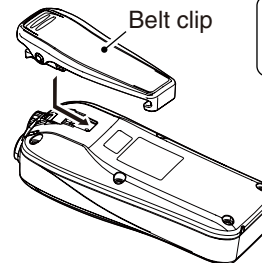

**Be careful!**  
Don't break your  
fingernail.

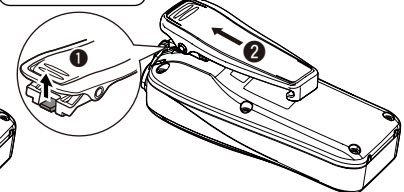

To detach the belt clip

Lift the tab up (1), and slide the belt clip in the direction of the arrow (2).

## ■ Charging

### IMPORTANT:

- Read Section 8 (Pages 22 to 24) before charging.
- Before using the transceiver for the first time, fully charge the battery for optimum life and operation.
- Turn OFF the power while charging to avoid damage to the battery.

### ❑ Charging with the supplied power adapter

- ① Turn OFF the power.
- ② Connect the power adapter as shown below.

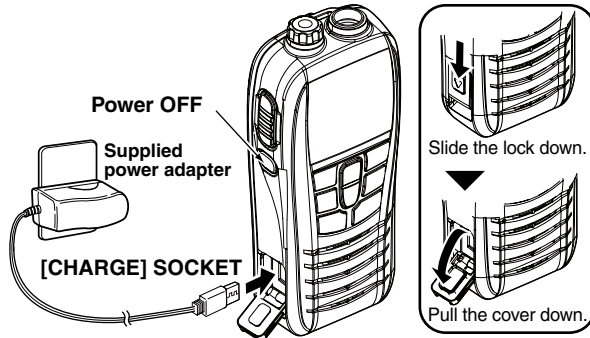

- "CHG" is displayed and bars inside of the battery icon scroll while charging.

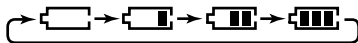

- When error is detected, the battery icon blinks, and "Er" and "CHG" are displayed.

- ③ The charging is completed in approximately 3 hours.
  - The charging time differs depending on the battery condition.
  - "FL" is displayed when the battery has been fully charged.

### For Reference: Charging with other power sources

- NOTE: Charging with these power sources is not guaranteed. Icom is not responsible for the destruction or damage to charging with these power sources.
- ▨ Charging time differs, depending on the power supply.

#### • PC'S USB port

Some PCs may not supply the required voltage and current.

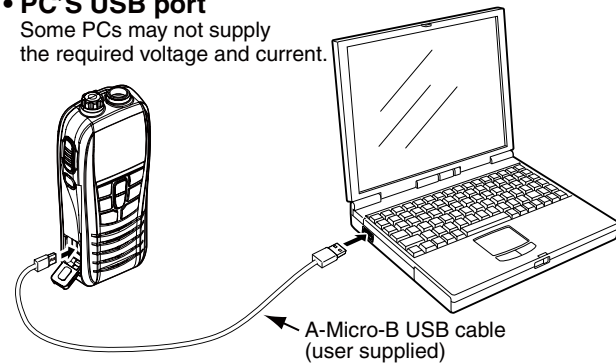

#### • Micro-B USB type charger\*

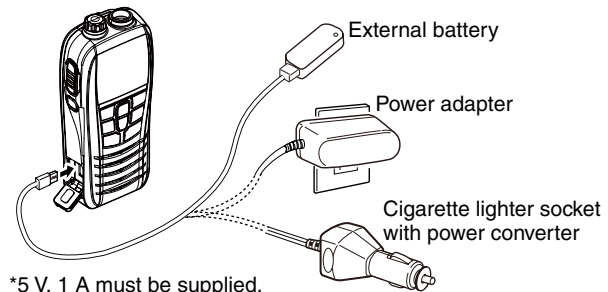

# 3

## PANEL DESCRIPTION

### ■ Front, top and side panels

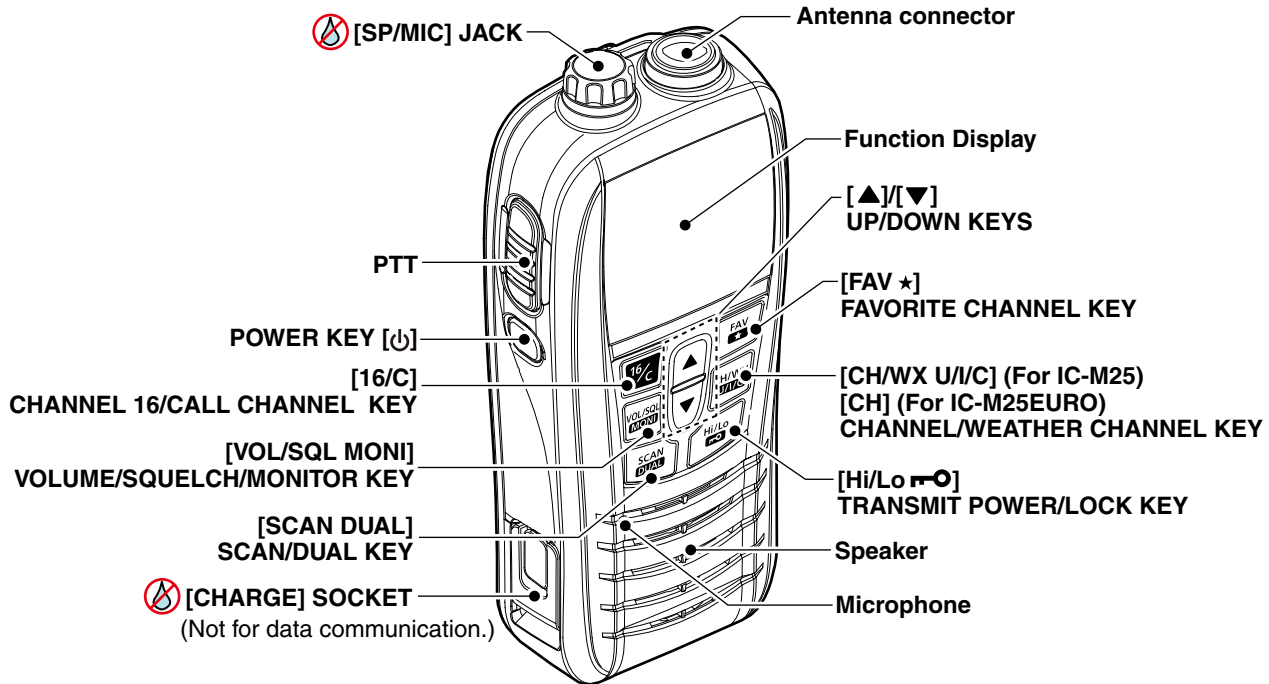

#### ⚠ CAUTION:

- Close up **securely** when no cable is conencted.
- Make **sure** dust or other material does not adhere to the rubber seal. Otherwise, waterproof protection may not be guaranteed.

**ANTENNA CONNECTOR** (Page 2)

Connect the supplied antenna here.

**SPEAKER/MIC JACK [SP/MIC]** (Page 25)

Connect the optional HM-213 SPEAKER MICROPHONE here.

Unscrew the cap.

Lift the cap to detach it.

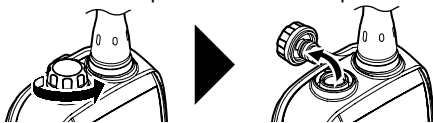

**PTT SWITCH [PTT]**

Hold down to transmit, release to receive.

**POWER KEY [⏻]**

Hold down to turn power ON or OFF.

**CHANNEL 16/CALL CHANNEL KEY [16/C]** (Page 9)



➔ Push to select Channel 16.

➔ Hold down for 1 second to select the Call channel.

**VOLUME/SQUELCH/MONITOR KEY [VOL/SQL MONI]**



➔ Push this key, and then push [▲] or [▼] to adjust the volume/squelch level.

• You can adjust the volume/squelch level while the “VOL”/“SQL” icon is blinking. (Pages 10 and 11)

**SCAN/DUAL KEY [SCAN DUAL]**



➔ Push to start or stop a scan. (Page 15)

➔ Hold down for 1 second to enter the Dual/Tri-watch mode. (Page 16)

➔ Hold down this key and [Hi/Lo] for 1 second, to activate the AquaQuake function. (Page 13)

**[CHARGE] SOCKET**

Connect the supplied charger. (Page 3)

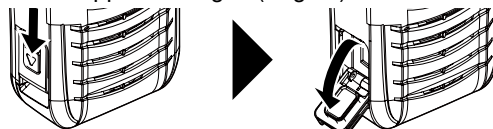

Slide down the cover lock.

Pull the cover down to open it.

**CAUTION: When closing the socket cover**

Stand the transceiver up straight. Otherwise, any water that is on the socket cover will get into the transceiver.

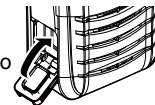

**UP/DOWN KEYS [▲] or [▼]**



➔ Push to select the operating channel.

➔ Push to change the volume/squelch level while adjusting.

➔ In the Set mode, push to select an item option.

**FAVORITE CHANNEL KEY [FAV \*]** (Page 15)



➔ Push to sequentially select a Favorite channels while ignoring normal channels.

➔ Hold down for 1 second to set or clear the selected Favorite channel.

**CHANNEL/WEATHER CHANNEL KEY [CH/WX U//C]/[CH]**



➔ Push to switch between a regular channel and weather channel. (Page 9)

➔ Hold down for 1 second to change the channel group. (Page 8)

**NOTE:** [CH] is described as [CH/WX U//C] in this instruction manual.

**TRANSMIT POWER/LOCK KEY [Hi/Lo] [⏻]**



➔ Push to set the output power to high or low. (Page 11)

➔ Hold down for 1 second to lock all keys except [PTT], [VOL/SQL MONI] and [Hi/Lo] [⏻]. (Page 12)

### 3 PANEL DESCRIPTION

## ■ Function Display

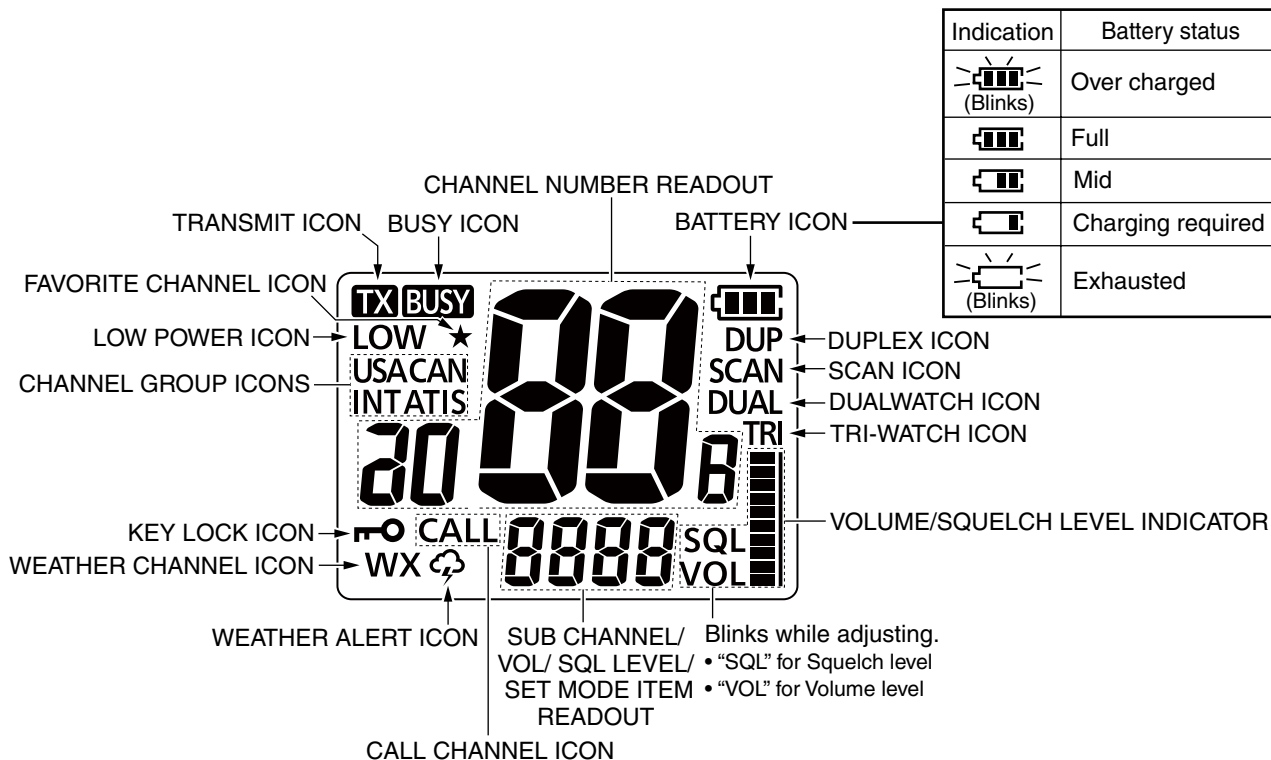

**TRANSMIT ICON**

Appears while transmitting.

**FAVORITE CHANNEL ICON**

Displayed when a Favorite channel is selected. (Page 15)

**LOW POWER ICON**

- Displayed when the low TX power is selected. (Page 11)
- Blinks when a high temperature error or low voltage is detected, and automatically switched to the low power.

**CHANNEL GROUP ICONS**

Display the selected channel group. (Page 8)

**KEY LOCK ICON**

Appears when the Lock function is turned ON. (Page 12)

**WEATHER CHANNEL ICON**

Displayed when the weather channel group is selected. (Page 9)

**WEATHER ALERT ICON**

Displayed while the Weather Alert function is turned ON, and blinks when the alert tone is received. (Page 9)

**CALL CHANNEL ICON**

Displayed when the Call channel is selected. (Page 9)

**SUB CHANNEL READOUT**

- Displays the volume/squelch level while adjusting the level. (Pages 10 and 11)
- Displays Channel 16 during a priority scan, Dualwatch or Tri-watch. (Pages 14 and 16)
- Displays the Set mode item while in the Set mode. (Page 17)

**VOLUME/SQUELCH LEVEL INDICATOR**

- Number of bars shows the volume/squelch level.
- “SQL” blinks when adjusting the squelch level. (Page 11)
- “VOL” blinks when adjusting the volume level. (Page 10)

**TRI-WATCH ICON**

Displayed during Tri-watch. (Page 16)

**DUALWATCH ICON**

Displayed during Dualwatch. (Page 16)

**SCAN ICON**

Blinks during a scan. (Page 14)

**DUPLEX ICON**

Displayed when a duplex channel is selected.

**BATTERY ICON**

- Displays the remaining battery capacity.
- Bars scroll inside the battery icon while charging. (Page 3)

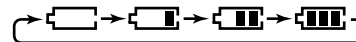

**CHANNEL NUMBER READOUT**

Displays the selected operating channel number.

**BUSY ICON**

- Appears while receiving a signal.
- Blinks while the Monitor function is ON. (Page 11)

## ■ Selecting a channel

Choose the appropriate channel group for your operating area, and then select the desired channel.

### □ Selecting a channel group

- ① Push [CH/WX] to exit the WX group if necessary.
- ② Hold down [U/I/C] (CH/WX) for 1 second to change the channel group. Repeat to advance to the next group.
  - The selectable channel groups differ, depending on the transceiver version.

#### For USA, EXP and CHN versions

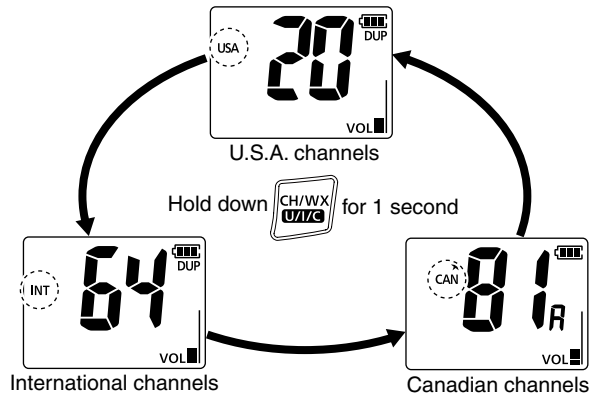

#### For UK and AUS versions

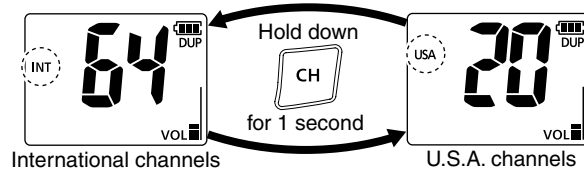

#### For HOL version

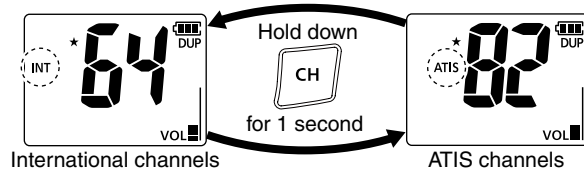

### □ Selecting a regular channel

- ➔ Push [▲] or [▼] to select a channel.
  - "DUP" appears for duplex channels.
  - "A" appears for simplex channels.

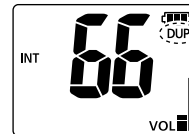

Duplex channel is selected.

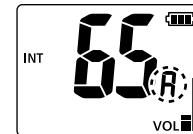

Simplex channel is selected.

**NOTE:** You cannot transmit on Channel 70.



**❑ Selecting Channel 16**

Channel 16 is the distress and safety channel. It is used for establishing initial contact with a station, and for emergency communications. While in the standby, you must monitor Channel 16.

- ① Push [16/C] to select Channel 16.
- ② Push [CH/WX] to recall the channel that was displayed before selecting Channel 16.

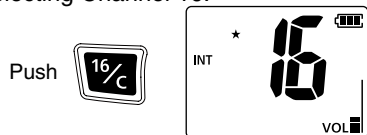

**❑ Selecting Call channel**

Each channel group has a Call channel.

- ① Hold down [16/C] for 1 second to select the Call channel of the selected channel group.
  - “CALL” and the Call channel number appear.
- ② Push [CH/WX] to recall the channel that was displayed before selecting Channel 9.

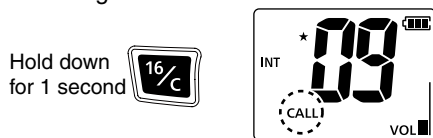

**NOTE:** You can set your most often-used channel. See page 13.

**❑ Weather channels**

**(For USA, EXP, CHN and AUS versions.)**

The transceiver has 10 weather channels. These are used for monitoring the broadcasts from the National Oceanic and Atmospheric Administration (NOAA).

- ① Push [CH/WX] once or twice to select the Weather channel group.
  - “WX” appears when a weather channel is selected.

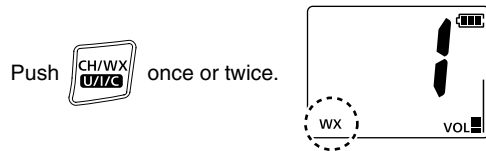

A weather channel is selected.

- ② Push [▲] or [▼] to select a weather channel.

**About the Weather Alert function:**

A NOAA broadcast station transmits a weather alert tone before any important weather announcements.

The Weather Alert function automatically detects a weather alert tone on the selected weather channel.

See page 18 for details.

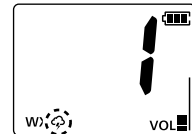

Weather Alert function is ON.

## 4 BASIC OPERATION

### ■ Receiving and transmitting

/// **CAUTION:** Transmitting without an antenna can damage the transceiver.

- 1) Push [▲] or [▼] to select a channel.
  - When a signal is received, “**BUSY**” appears.
- 2) Hold down [PTT], and then speak into the microphone.
  - “**TX**” appears while transmitting.
  - You cannot transmit on Channel 70.
- 3) Release [PTT] to receive.

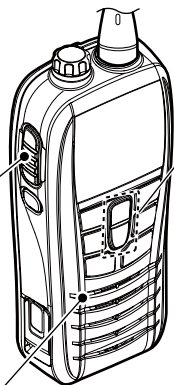

1) Select a channel.

2) Push to transmit.  
4) Release to receive.

3) Speak into the microphone.

/// **IMPORTANT:** To maximize the readability of your transmitted signal, pause for a second after pushing [PTT], hold the microphone 5 to 10 cm (2 to 4 inches) from your mouth and speak at a normal voice level.

/// **NOTE:** To conserve battery power, the transceiver's Power Save function automatically activates when no signal is received for 5 seconds.

/// **For USA and AUS versions:** To prevent prolonged transmission, a time-out timer cuts OFF after 5 minutes of continuous transmission.

### ■ Adjusting the volume level

You can adjust the volume level while the “**VOL**” icon is blinking.

- 1) Push [VOL/SQL] once.
  - The “**VOL**” icon starts blinking.
  - If no key operation is performed for 5 seconds, the transceiver

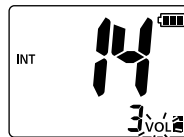

↑ While blinking, adjust the volume.  
Volume level.

- returns to the normal operating mode.
- 2) Push [▲] or [▼] to adjust the volume level.
  - The level is displayed on the screen.
- 3) Push [VOL/SQL] twice.
  - Returns to the normal operating mode.

## ■ Adjusting the squelch level

Squelch is a function that allows the audio to be heard only while receiving a signal that is stronger than a set level. You can adjust the squelch threshold level.

A higher level blocks weak signals, so you receive only stronger signals. A lower level allows you to hear weak signals including noise.

💡 **Adjust the squelch level when you want to:**

- block weak signals including noise → Set the level higher.
- hear weak signals, even in the noise → Set the level lower.

You can adjust the squelch level while the “SQL” icon is blinking.

- ① Push **[VOL/SQL]** twice.
  - The “SQL” icon starts blinking.
  - If no key operation is performed for 5 seconds, the transceiver returns to the normal operating mode.

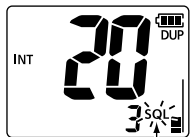

↑ While blinking, adjust the squelch.  
Squelch level.

- ② Push **[▲]** or **[▼]** to adjust the squelch level.
  - The level is displayed on the screen.
- ③ Push **[VOL/SQL]** once.
  - Returns to the normal operating mode.

## ■ Monitor function

The Monitor function momentary cancels the squelch function. You can check for weak signals.

- ➔ Hold down **[MONI]** (VOL/SQL) for 1 second.
  - “**BUSY**” blinks.
  - If there is a weak signal, you can hear the signal and noise.
  - Release **[MONI]** (VOL/SQL) to turn OFF this function.

Blinks while the function is activated.



**NOTE:** This function has options. See page 19 for more.

## ■ Toggling the transmit power

If you receive no response to your call, your transmitted signal might not reached the person you called. Choose high power for longer distance communications.

On the other hand, transmitting at low power is enough to communicate, according to the distance. Choose low power for short range communication and battery conservation.

- ➔ Push **[Hi/Lo]** to toggle the transmit power between low and high.
  - “**LOW**” is displayed when low power is selected. No indication is displayed when high power is selected.

**NOTE:**

- Some channels are restricted to low power.
- You cannot transmit on Channel 70.

## 4 BASIC OPERATION

### ■ Volume Loud function

You can temporary maximize the volume level with a simple operation.

- ➔ While holding down [VOL/SQL], push [▲].
  - The volume level is set to the maximum level.
  - Push [VOL/SQL] and [▲] again to turn OFF the function.

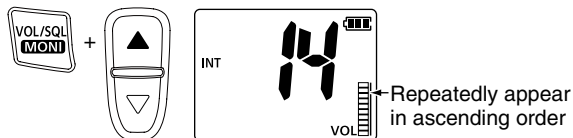

### ■ Volume Mute function

You can temporary mute the audio output with a simple operation.

- ➔ While holding down [VOL/SQL], push [▼].
  - The volume level is set to the minimum level (OFF).
  - Push [VOL/SQL] and [▼] again to turn OFF the function.

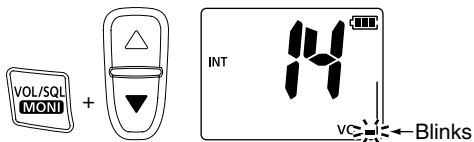

### ■ Lock function

This function electronically locks most keys to prevent accidental changing of the channel and function access.

- ➔ Hold down [Hi/Lo] for 1 second to turn the function ON or OFF.



**NOTE:**  
[PTT], [VOL/SQL], [MONI] (VOL/SQL) and [Hi/Lo] are not locked.  
[▲] and [▼] are not locked when adjusting the volume or squelch, or when the Volume Loud or Volume Mute function is turned ON.

## ■ AquaQuake Water Draining function

Water in the speaker grill may muffle the sound coming from the speaker. The AquaQuake Water Draining function removes water from the speaker grill, by generating vibrating the speaker.

- ➔ Hold down both **[SCAN]** and **[Hi/Lo]** for 1 second.
  - A low vibration tone sounds for 10 seconds to drain water, regardless of the volume level setting.
  - This function also stops when a key is pushed.

**NOTE:** This function does not activate when an external speaker microphone is connected.

## ■ Setting the Call channel

You can recall the most often-used channel with a single operation, by setting the channel as the Call channel. The Call channel can be set in each channel group.

- ① Hold down **[U/I/C]** (CH/WX) for 1 second to change the channel group. Repeat to go to the desired group.
- ② Hold down **[16/C]** for 1 second to recall the current Call channel in the selected group.
  - “CALL” and the Call channel number appear.
- ③ Hold down **[16/C]** again for 3 seconds (until a long beep changes to 2 short beeps) to enter the Call channel setting mode.
  - The channel number starts blinking.



- ④ Push **[▲]** or **[▼]** to select the new Call channel.



- ⑤ Push **[16/C]** to set the displayed channel.
  - 2 short beeps sound.
  - The channel number stops blinking.

## ■ Scan types

You can find ongoing calls by scanning the Favorite channels.

### Before starting a scan, you need to:

- Set the desired channels you want to scan as Favorite channels (Page 15). (Only Favorite channels are scanned.)
- Set the desired scan type to "Normal (default)" or "Priority" in the Set mode (Page 18).

### NORMAL SCAN

A normal scan sequentially searches through all Favorite channels. However, Channel 16 is not checked unless it is set as a Favorite channel.

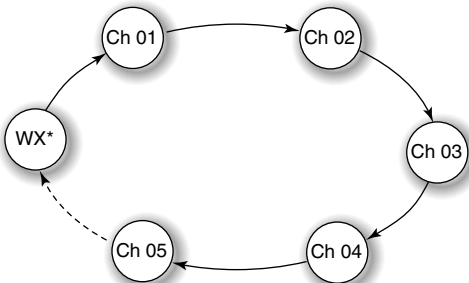

\*For USA, EXP, CHN and AUS versions.  
When the Weather Alert function is activated,  
the previously selected weather channel is also scanned.

### PRIORITY SCAN

A priority scan sequentially searches through all Favorite channels while also monitoring Channel 16.

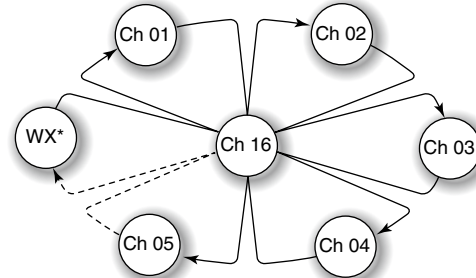

\*For USA, EXP, CHN and AUS versions.  
When the Weather Alert function is activated,  
the previously selected weather channel is also scanned.

### When a signal is received:

#### • On Channel 16

The scan pauses until the signal on Channel 16 disappears.

#### • On a channel other than Channel 16:

The scan switches to Dualwatch, until the signal disappears.

## ■ Setting Favorite channels

You can quickly recall often-used channels by setting them as Favorite channels, which can be independently assigned to each channel group.

- ① Hold down **[U/I/C]** (CH/WX) for 1 second to change the channel group, if needed. Repeat to go to the next group.
- ② Select the desired channel to be set as a Favorite channel.
- ③ Hold down **[\*]** for 1 second.
  - The displayed channel is set as a Favorite channel.
  - “\*” appears on the display.

### Selecting a Favorite channel:

- ➔ Push **[FAV]** several times to select the desired Favorite channel.
  - Non-Favorite channels are skipped and not displayed.
  - You can also select the favorite channels by pushing **[▲]** or **[▼]** while holding down **[FAV]**.

### Clearing a Favorite channel:

- ① Select the desired Favorite channel you want to clear.
- ② Hold down **[\*]** for 1 second.
  - “\*” disappears.

### Clearing all Favorite channels:

- ➔ While holding down **[\*]** (FAV), turn ON the power.
  - All Favorite channels in the selected channel group are cleared.
  - When no channel is set as Favorite channel: Holding down **[\*]** (FAV), turn ON the power sets all channels as Favorite channels.

## ■ Starting a scan

- ① Hold down **[U/I/C]** (CH/WX) for 1 second to change the channel group. Repeat to advance to the desired group.
  - When the Weather Alert function is in use, select a desired weather channel by pushing **[CH/WX]** and **[▲]** or **[▼]**.
- ② Push **[SCAN]** to start a scan.
  - “SCAN” blinks while scanning.
  - During a priority scan, “16” appears on the sub channel readout.
  - When a signal is received, the scan pauses until the signal disappears, or resumes after pausing 5 seconds, depending on the Scan Resume Timer setting.
- ③ To stop the scan, push **[SCAN]** again.
  - “SCAN” disappears.
  - Pushing **[PTT]**, **[16/C]**, **[CH/WX]** or **[FAV]** also stops the scan.

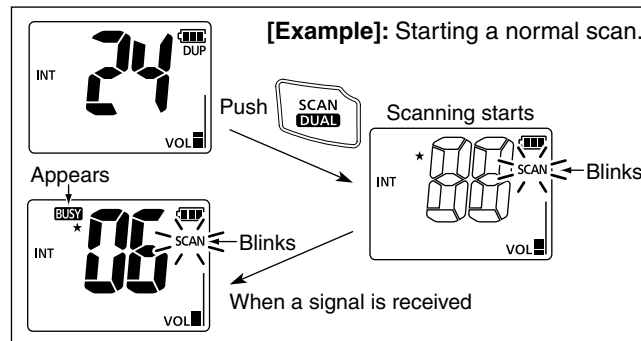

### NOTE:

In order to properly receive signals, the squelch must be adjusted to the proper level. (Page 11)

## ■ Description

Dualwatch and Tri-watch are convenient to monitor Channel 16 while you are operating on another channel.

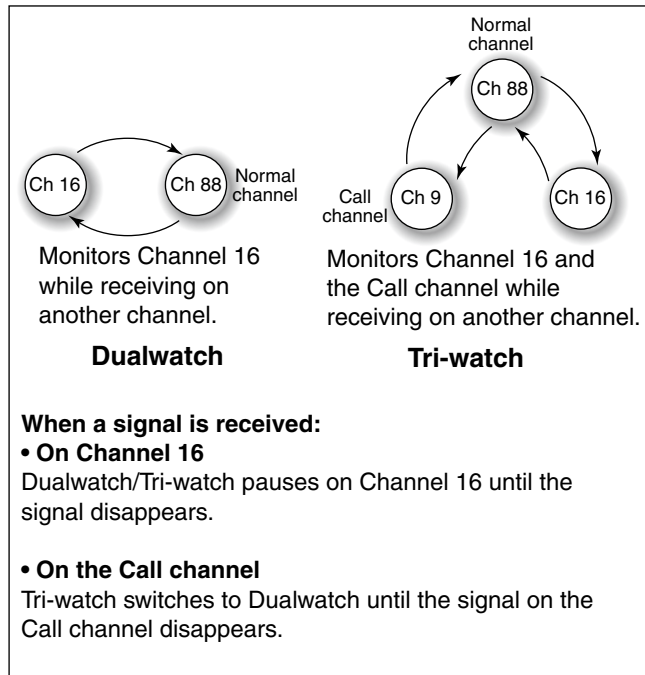

## ■ Operation

- ① Select Dualwatch or Tri-watch in the Set mode. (Page 19)
- ② Select the desired channel.
- ③ Hold down **[DUAL]** (SCAN) for 1 second to start Dualwatch or Tri-watch.
  - “**DUAL**” blinks during Dualwatch. “**TRI**” blinks during Tri-watch.
  - A beep tone sounds when a signal is received on Channel 16.
- ④ To cancel Dualwatch or Tri-watch, push **[DUAL]** (SCAN) again.

### [Example]: Operating Tri-watch on INT channel 07.

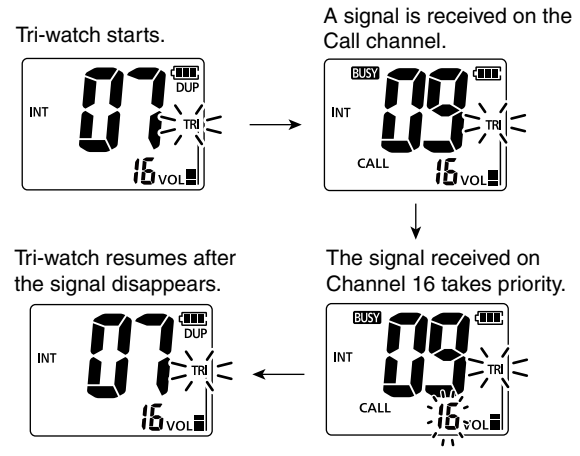



## ■ Set mode entry

The Set mode is used to select option for the transceiver's functions.

### □ Set mode operation

- ① Turn OFF the power.
- ② While holding down [VOL/SQL], turn ON the power to enter the Set mode.
  - The starting item "bBEEP" appears.
- ③ While holding down [VOL/SQL], push [▲] or [▼] to select an item.
- ④ Push [▲] or [▼] to select an item option.
- ⑤ Push [16/C] to exit the Set mode.

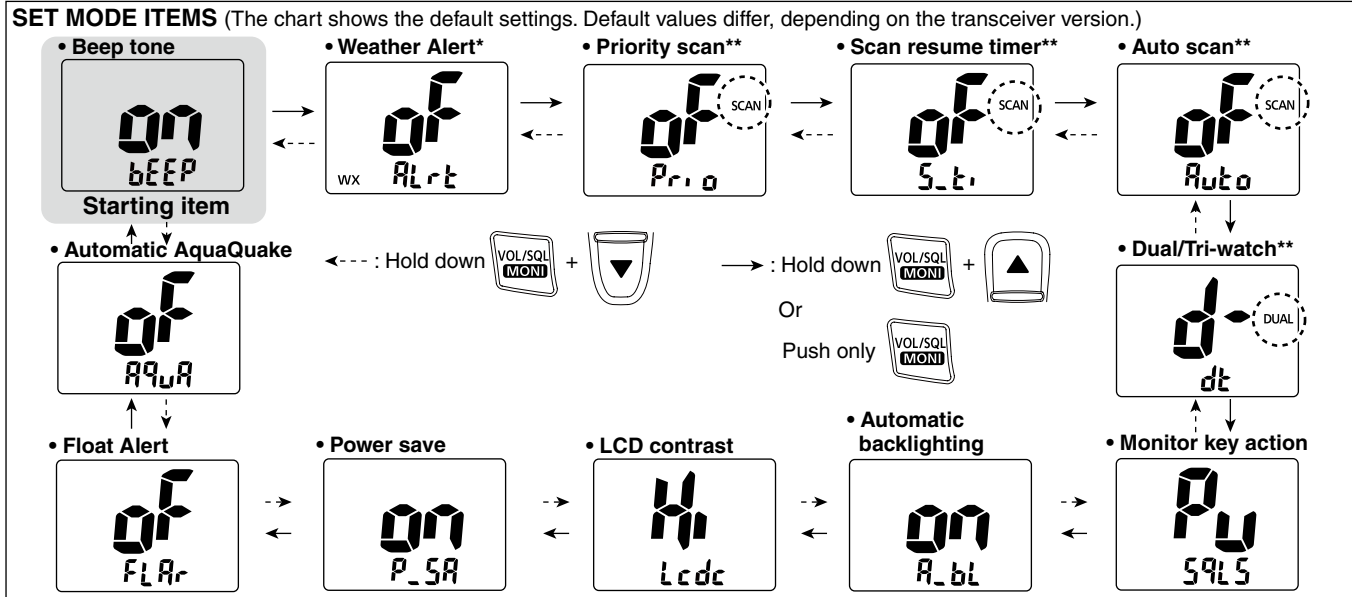

\*For USA, EXP, CHN and AUS versions.

\*\*Not available in the HOL version.

## ■ Set mode items

### □ Beep Tone function

“bEEP”

Turn the key touch beep sound ON or OFF.

- OFF: For silent operation.
- ON: A beep sounds when a key is pushed.

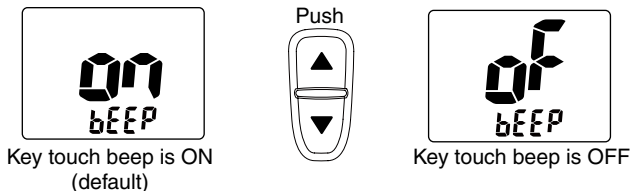

### □ Weather Alert function

“ALrt”

(For USA, EXP, CHN and AUS versions)

When this function is turned ON and the transceiver detects a weather alert tone, the “WX ↻” icon blinks and a beep sounds. (The blinking stops when another key is pushed.)

The currently selected weather channel is monitored even while receiving another channel (when the Power Save function is ON) or during a scan.

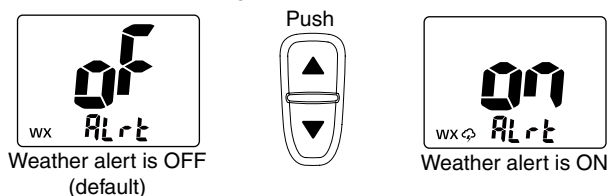

### □ Priority Scan function

“Prio”

(Not available in the HOL version)

The transceiver has 2 scan types — “Normal” and “Priority.”

- OFF: A normal scan, which searches all Favorite channels in the selected channel group.
- ON: A priority scan, which sequentially searches all Favorite channels while monitoring Channel 16.

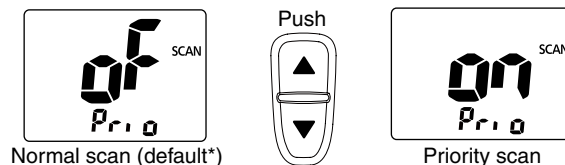

\*Default value differs, depending on the transceiver version.

### □ Scan resume timer

“S\_ti”

(Not available in the HOL version)

Select a scan resume timer option.

- OFF: When a signal is received, the scan pauses on the channel until the signal disappears.
- ON: When a signal is received, the scan pauses on the channel for 5 seconds, and then resumes.

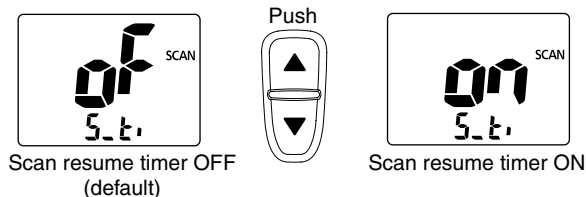

**Auto Scan function**

“Auto”

(Not available in the HOL version)

The Auto Scan function automatically starts a normal or priority scan when no signal is received, and no operation is performed for 30 seconds.



Auto scan OFF (default)

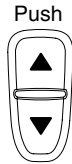

Auto scan ON

**Dual/Tri-watch function**

“dt”

(Not available in the HOL version)

Set the watch type to Dualwatch or Tri-watch.

- d- : Dualwatch.
- t- : Tri-watch.

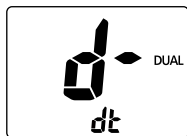

Dualwatch function (default)

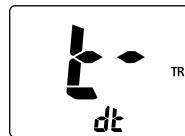
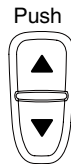

Tri-watch function

**Monitor key action**

“SqLS”

The monitor key momentary activates the Monitor function. Select a key action option.

- Pu (PUSH): The Monitor function is activated while holding down [MONI] (VOL/SQL) for more than 1 second. The squelch function is canceled while holding down the key.
- Ho (HOLD): The Monitor function is activated by holding down [MONI] (VOL/SQL) for more than 1 second. The squelch function is canceled until [MONI] (VOL/SQL) is pushed again.

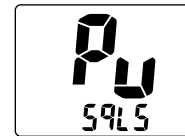

Push setting (default)



Hold setting

## 7 SET MODE

### ■ Set mode items (Continued)

#### □ Automatic backlighting

“A\_bl”

This function is convenient for the operation in low light. The backlight can be turned ON or OFF.

- The backlight is automatically activated when you push any key other than [PTT].
- The backlight is automatically turned OFF after 5 seconds of inactivity.



Backlighting ON (default)

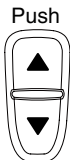

Backlighting OFF

#### □ LCD contrast setting

“Lcdc”

Set the LCD contrast level to High or Low.



High contrast (default)

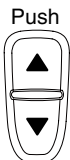

Low contrast

⚡ The LCD contrast level has little effect during indoor use.

#### □ Power Save function

“P\_SA”

The Power Save function reduces current drain by periodically turning OFF the receiver circuit.

- OFF: The function is turned OFF.
- ON: When no signal is received, and no operation is performed for 5 seconds, the receiver circuit is periodically turned OFF.



Power Save ON  
(default)

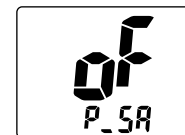

Power Save OFF

**Floats and Flashes Alarm function “FLAr”**

Alarm periodically sounds while the transceiver is floating in the water, to allow you to find the transceiver in the water.

- OFF: The function is OFF.
- ON: Alarm periodically sounds while the transceiver is floating in the water. This function stops when a key is pushed or 10 seconds have past after the transceiver is retrieved from the water.

⚡ **CAUTION:** The alarm sounds loudly.



Alarm OFF (default)

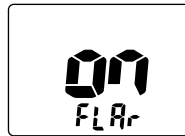

Alarm ON

**Automatic AquaQuake function “Aqua”**

This function automatically activates the AquaQuake Water Draining function when the transceiver is retrieved from the water.

- OFF: The function is OFF.
- 2/5/10: The AquaQuake Water Draining function is automatically activated after stopping the floating alarm sound. A low vibration tone sounds for the specified time of 2, 5 or 10 seconds, to remove water from the speaker grill.

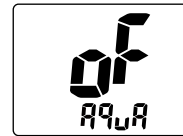

OFF (default)



2

⚡ **NOTE:** This function does not activate when an external speaker microphone is connected.

## ■ Battery caution

Misuse of Lithium-ion batteries may result in smoke, fire, or the battery may rupture.

Misuse can also cause damage to the battery or degradation of battery performance.

⚠ **DANGER!** Use and charge only specified Icom battery pack with Icom transceiver. Only Icom battery pack is tested and approved for use with Icom transceiver. Using third-party or counterfeit battery packs may cause smoke, fire, or cause the battery to burst.

### □ Battery caution

⚠ **DANGER! DO NOT** hammer or otherwise impact the battery. Do not use the battery if it has been severely impacted or dropped, or if the battery has been subjected to heavy pressure. Battery damage may not be visible on the outside of the case. Even if the surface of the battery does not show cracks or any other damage, the cells inside the battery may rupture or catch fire.

⚠ **DANGER! NEVER** use or leave battery pack in areas with temperatures above +60°C (+140°F). High temperature buildup in the battery, such as could occur near fires or stoves, inside a sun-heated car, or by setting the battery in direct sunlight may cause the battery to rupture or catch fire. Excessive temperatures may also degrade battery performance or shorten battery life.

⚠ **DANGER! DO NOT** expose the battery to rain, snow, seawater, or any other liquids. Do not charge or use a wet battery. If the battery gets wet, be sure to wipe it dry before using. The battery by itself is not waterproof.

⚠ **DANGER! NEVER** incinerate the transceiver since internal battery gas may cause them to rupture or may cause an explosion.

⚠ **DANGER! NEVER** solder the battery terminals, or **NEVER** modify the battery pack. This may cause heat generation, and the battery may rupture, emit smoke or catch fire.

⚠ **DANGER!** Use the battery only with the transceiver for which it is specified. Never use a battery with any other equipment, or for any purpose that is not specified in this instruction manual.

⚠ **DANGER!** If fluid from inside the battery gets in your eyes, blindness can result. Rinse your eyes with clean water, without rubbing them, and see a doctor immediately.

⚠ **WARNING!** Immediately stop using the battery if it emits an abnormal odor, heats up, or is discolored or deformed. If any of these conditions occur, contact your Icom dealer or distributor.

⚠ **WARNING!** Immediately wash, using clean water, any part of the body that comes into contact with fluid from inside the battery.

⚠ **WARNING! NEVER** put the transceiver/battery in a microwave oven, high-pressure container, or in an induction heating cooker. This could cause overheating, a fire, or cause the internal battery to rupture.

**CAUTION:** Always use the transceiver/battery within the specific temperature range.

- For the USA and EXP versions:  
–20°C (–4°F) to +60°C (+140°F)
- For the EUR, FRG, HOL, UK and CHN versions:  
–15°C (+5°F) to +55°C (+131°F)
- For the AUS version:  
–10°C (+14°F) to +55°C (+131°F)

Using the battery out of its specified temperature range will reduce the battery’s performance and battery life. Please note that the specified temperature range of the battery may exceed that of the transceiver. In such cases, the transceiver may not work properly because it is out of its operating temperature range.

**CAUTION:** Shorter battery life could occur if the battery is left fully charged, completely discharged, or in an excessive temperature environment (above +50°C; +122°F) for an extended period of time. If the transceiver must be left unused for a long time, you may use the transceiver until the battery icon shows half capacity, then keep the transceiver safely in a cool dry place with the temperature range as follows:

- 20°C to +50°C (–4°F to +122°F) (within a month)
- 20°C to +35°C (–4°F to +95°F) (within three months)
- 20°C to +25°C (–4°F to +77°F) (within a year)

### ❑ Charging caution

⚠ **DANGER! NEVER** charge the battery in areas with extremely high temperatures, such as near fires or stoves, inside a sun-heated car, or in direct sunlight. In such environments, the safety/protection circuit in the battery will activate, causing the battery to stop charging.

**WARNING! DO NOT** leave the transceiver connected to the AC power adapter beyond approximately 6 hours. If the battery is not completely charged by the specified time, stop charging and remove the battery from the battery charger. Continuing to charge the battery beyond the specified time limit may cause a fire, overheating, or the battery may rupture.

**WARNING! NEVER** connect the power adapter to the transceiver if the transceiver is wet or soiled. This could corrode or damage the **[Charge]** socket. The supplied power adapter is not waterproof.

**CAUTION: DO NOT** charge the battery outside of the following temperature range.

0°C (+32°F) to +45°C (+113°F)

Icom recommends charging the battery at +20°C (+68°F). The battery may heat up or rupture if charged out of the specified temperature range, and battery performance or battery life may be reduced.

## 8 ABOUT THE BATTERY

### ❑ Charging caution (Continued)

**TURN OFF** the power before charging, to avoid damage to the battery. **Charge** the battery at least once every six months, even if it has been not used for a long period of time. The battery will have slowly self-discharged, even though it has not been used. If the battery is left for a long period without being charged, its life cycle will be shorter, or worse, it will never accept a charge again.

### ❑ Battery lifetime and replacement

The internal battery material will become weak after a period of time, even with little use. The estimated number of charging and discharging cycles is between 300 and 500, depending on the type of operation.

Even when the battery appears to be fully charged, the operating time of the transceiver may become short when:

- Approximately five years have passed since the battery was manufactured.
- The battery has been repeatedly charged.

**BE SURE** to replace the battery with a new one approximately five years after manufacturing, even if it still holds a charge.

Contact your Icom's local service shop or authorized Icom dealer about the battery replacement.

(Icom global site: <http://www.icom.co.jp/world/>)

### ❑ Battery disposal

Rechargeable batteries must be taken to designated collection locations at the end of their working life. Do not dispose of these products as unsorted municipal waste. Dispose of them according to the laws in your area.

#### Removing the battery pack from the transceiver

/// **NOTE:** If the transceiver and/or your hands are wet, be sure to dry them before disassembly.

- ① Turn OFF the power.
- ② Remove the six screws from the rear panel.
- ③ Open the case.
- ④ Remove the battery connector and the red sensor wire connector from the front panel.
- ⑤ Pull the battery pack off the rear panel.

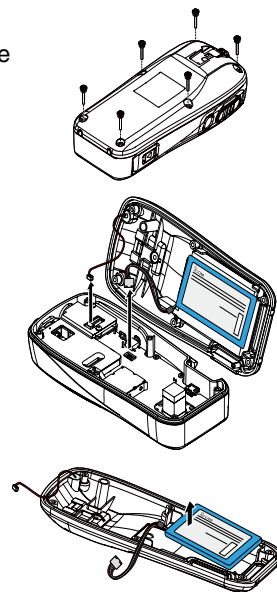



# OPTIONAL SPEAKER-MICROPHONE (HM-213)

9

## ■ Descriptions

The HM-213 SPEAKER MICROPHONE is a lightweight speaker microphone. It fits in the palm of your hand and allows you to talk and listen more easily.

### Alligator type clip

To attach the speaker-mic. to your shirt or collar.

### PTT switch

Push to transmit, release to receive.

### Microphone

### Speaker

Turn the transceiver power OFF when connecting the HM-213.

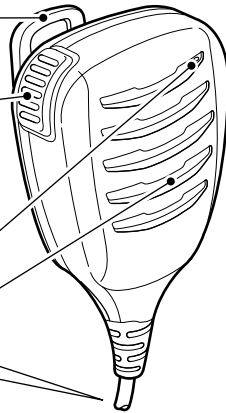

**NEVER** immerse the connector in water. If the connector gets wet, be sure to dry it **BEFORE** connecting it to the transceiver.

**NOTE:** The microphone is located at the top of the speaker-microphone, as shown above. To maximize the readability of your transmitted signal (voice), hold the microphone approximately 5 to 10 cm (2 to 4 inches) from your mouth, and speak at your normal voice level.

## ■ Attaching

Turn OFF the power. Then, insert the speaker-mic connector into the [SP/MIC] connector and securely screw it, as shown below. Be careful not to cross-thread the connection.

**CAUTION:** Attach the speaker-microphone's connector securely to prevent accidental loss, or water intrusion into the connector.

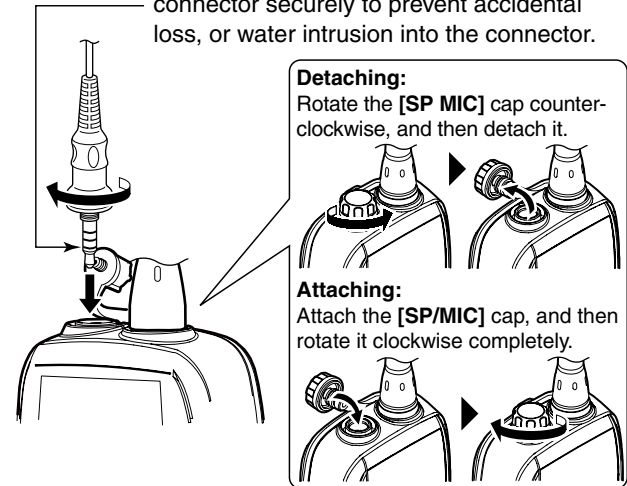

### Detaching:

Rotate the [SP/MIC] cap counter-clockwise, and then detach it.

### Attaching:

Attach the [SP/MIC] cap, and then rotate it clockwise completely.

**IMPORTANT: KEEP** the transceiver's [SP/MIC] cap attached when the speaker-microphone is not used. If the cover is not attached, water will get into the transceiver. Moreover, the terminals (pins) will become rusty, or the transceiver will function abnormally if the connector gets wet.

8

9

# 10 ATIS CODE (For only the HOL and FRG versions)

The 10-digit ATIS code can be set and confirmed.

## Depending on the dealer setting:

- The ATIS code setting may not be necessary.
- The code can be set only one time.

### ❑ Setting the ATIS code

- ① Turn OFF the power.
- ② While holding down [16/C], push [⏻].
  - Enters to the ATIS Code Setting mode.
- ③ Push [▲] or [▼] to select the number for the first digit of the ATIS code.
- ④ Push [CH/WX] to select the next digit, and then push [▲] or [▼] to select a number.
  - Pushing [VOL/SQL] selects the previous digit.
- ⑤ After the 10th digit has been input, push [Hi/Lo] to store the code.
  - The code number stops blinking.
  - Push [16/C] to return to the normal operating mode.

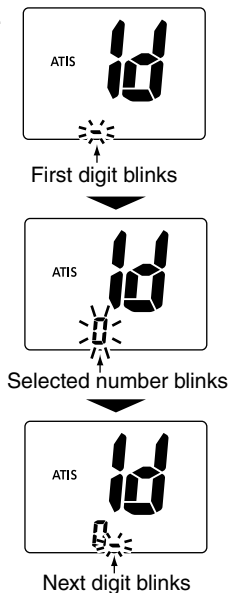

### ❑ ATIS code confirmation

(Can be performed only when the ATIS code has been programmed.)

- ① Turn OFF the power.
- ② While holding down [16/C], push [⏻] to enter the ATIS code confirmation mode.
  - The digit number and the stored code number appear.
  - Push [CH] to select the next digit, push [VOL/SQL] to select the previous digit.
- ③ Push [16/C] to exit the ATIS Confirmation mode.

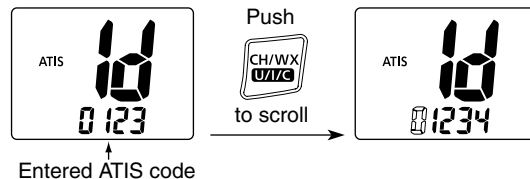

PROBLEM	POSSIBLE CAUSE	SOLUTION	REF.
The transceiver does not turn ON.	<ul style="list-style-type: none"> <li>The battery is exhausted.</li> </ul>	<ul style="list-style-type: none"> <li>Charge the battery.</li> </ul>	Page 3
No sound from speaker, or sound is muffled.	<ul style="list-style-type: none"> <li>The squelch level is too high.</li> <li>Volume level is too low.</li> <li>The Volume Mute function is ON.</li> <li>Speaker has been exposed to water.</li> </ul>	<ul style="list-style-type: none"> <li>Adjust the squelch level.</li> <li>Adjust the volume level.</li> <li>Turn OFF the function.</li> <li>Remove water from the speaker grill.</li> </ul>	Page 11 Page 10 Page 12 Page 13
Transmitting is impossible, or high power can not be selected.	<ul style="list-style-type: none"> <li>Some channels are limited to low power or only receive.</li> <li>The output power is set to low.</li> <li>The battery is exhausted.</li> </ul>	<ul style="list-style-type: none"> <li>Select a different channel.</li> <li>Push <b>[Hi/Lo]</b> to select high power.</li> <li>Charge the battery.</li> </ul>	Pages 31, 32, 33  Page 11 Page 3
The displayed channel cannot be changed.	<ul style="list-style-type: none"> <li>The Lock function is activated.</li> </ul>	<ul style="list-style-type: none"> <li>Hold down <b>[]</b> (Hi/Lo) for 1 second to turn OFF the function.</li> </ul>	Page 12
Scan does not start	<ul style="list-style-type: none"> <li>Less than 2 channels are set as Favorite channel. (Only Favorite channels are scanned.)</li> </ul>	<ul style="list-style-type: none"> <li>Set desired channels as Favorite channels.</li> </ul>	Page 15
No beep sounds.	<ul style="list-style-type: none"> <li>Beep Tone function is turned OFF.</li> </ul>	<ul style="list-style-type: none"> <li>Turn ON the Beep Tone in the Set mode.</li> </ul>	Page 18
The battery icon blinks, and "Er" and "CHG" are displayed.	<ul style="list-style-type: none"> <li>The battery is charged outside the charging temperature range of 0°C (+32°F) to +45°C (+113°F).</li> <li>The battery temperature becomes hot such as after continuously transmitting for long time.</li> </ul>	<ul style="list-style-type: none"> <li>Keep the transceiver in a cool place until the internal battery cools down.</li> </ul>	—
The battery cannot be fully charged.	<ul style="list-style-type: none"> <li>The transceiver power is turned ON while charging.</li> <li>The internal battery has become weak.</li> </ul>	<ul style="list-style-type: none"> <li>Turn OFF the transceiver's power, and then charge the battery again.</li> <li>Replace the internal battery. Ask your dealer for details.</li> </ul>	Page 3  Page 24

# 12 SPECIFICATIONS AND OPTIONS

## ■ Specifications

### □ GENERAL

#### ● IC-M25 (Except [CHN])

- Frequency coverage (MHz):

TX	156.025–157.425	
RX	156.050–163.275	
- Mode: FM (16K0G3E)
- Power supply voltage: 3.7 V DC nominal (negative ground)
- Current drain (approximately):

TX (5 W/1.0 W)	2.3 A/0.9 A
Maximum audio (internal SP)	0.30 A
Maximum audio (external SP)	0.20 A
- Frequency stability: ±10 ppm
- Operating temperature:  
–20°C to +60°C (–4°F to +140°F)
- Dimensions (projections not included):  
56.6 (W) × 134.2 (H) × 30.5 (D) mm,  
2.2 (W) × 5.3 (H) × 1.2 (D) inch
- Weight: 220 g, 7.8 oz (approximately)  
(including the supplied antenna and belt clip)

#### ● IC-M25EURO/IC-M25 only [CHN]

- Frequency coverage (MHz):

TX	156.000–161.450	[EUR], [FRG], [UK] and [CHN]
	156.000–161.600	[HOL]
	156.025–157.425	[AUS]
RX	156.000–163.425	[EUR], [FRG], [HOL], [UK] and [CHN]
	156.300–162.025	[AUS]
- Mode: FM (16K0G3E)
- Power supply voltage: 3.7 V DC nominal (negative ground)
- Current drain (approximately):

TX (5.0 W/1.0 W/0.5 W*)	2.3 A/0.9 A/0.7 A*
-------------------------	--------------------

\*For only [FRG]

Maximum audio (internal SP)	0.30 A
Maximum audio (external SP)	0.20 A
- Frequency stability:

±1.5 kHz	[EUR], [FRG], [HOL], [UK] and [CHN]
±10 ppm	[AUS]
- Operating temperature:

–15°C to +55°C	[EUR], [FRG], [HOL], [UK] and [CHN]
–10°C to +55°C	[AUS]
- Dimensions (projections not included):  
56.6 (W) × 134.2 (H) × 30.5 (D) mm,  
2.2 (W) × 5.3 (H) × 1.2 (D) inch
- Weight (approximately):  
220 g, 7.8 oz (including the supplied antenna and belt clip)

**□ TRANSMITTER****● IC-M25 (Except [CHN])**

- Output power: 5 W (approximately)/1 W
- Modulation system: Variable reactance frequency modulation
- Maximum frequency deviation:  $\pm 5$  kHz
- Adjacent channel power: 70 dB
- Spurious emissions:  $-68$  dBc typical
- Residual modulation: 40 dB
- Audio frequency response:  $+1$  dB to  $-3$  dB of 6 dB octave from 300–3000 Hz

**● IC-M25EURO/IC-M25 only [CHN]**

- Output power: 5 W (approximately)/1 W/0.5 W\*  
\*For only [FRG]
- Modulation system: Variable reactance frequency modulation
- Maximum frequency deviation:  $\pm 5$  kHz
- Adjacent channel power: 70 dB
- Spurious emissions: 0.25  $\mu$ W [EUR], [FRG], [HOL], [UK] and [CHN]  
0.25  $\mu$ W typical [AUS]
- Residual modulation: 40 dB
- Audio frequency response:  $+1$  dB to  $-3$  dB of 6 dB octave from 300–3000 Hz

**□ RECEIVER****● IC-M25 (Except [CHN])**

- Sensitivity : 0.25  $\mu$ V ( $-12$  dB $\mu$ ) typical (at 12 dB SINAD)
- Squelch sensitivity: 0.25  $\mu$ V ( $-12$  dB $\mu$ ) typical (at threshold)
- Intermodulation: 70 dB typical
- Spurious response: 70 dB typical
- Adjacent channel selectivity: 70 dB typical
- Audio output impedance: 12  $\Omega$  (internal speaker)  
4  $\Omega$  (external speaker)
- Audio output power: Internal SP 0.55 W typical  
(at 10% distortion) External SP 0.30 W typical

**● IC-M25EURO/IC-M25 only [CHN]**

- Sensitivity :  $-6$  dB $\mu$  emf typical (at 20 dB SINAD)
- Squelch sensitivity:  $-6$  dB $\mu$  emf typical (at threshold)
- Intermodulation: 68 dB [EUR], [FRG], [HOL], [UK] and [CHN]  
65 dB [AUS]
- Spurious response: 70 dB [EUR], [FRG], [HOL], [UK] and [CHN]  
65 dB [AUS]
- Adjacent channel selectivity: 70 dB [EUR], [FRG], [HOL], [UK] and [CHN]  
65 dB [AUS]
- Audio output impedance: 12  $\Omega$  (internal speaker)  
4  $\Omega$  (external speaker)
- Audio output power: Internal SP 0.55 W typical (at 1 kHz)  
(at 10% distortion) External SP 0.20 W

All stated specifications are subject to change without notice or obligation.

---

## 12 SPECIFICATIONS AND OPTIONS

### ■ Options

#### □ CHARGER

- **BC-217** POWER ADAPTER (same as the supplied\* one)

\*Not supplied, depending on the transceiver version.

#### □ OTHER OPTIONS

- **FA-SC59V** ANTENNA (same as the supplied one)
- **MB-133** BELT CLIP (same as the supplied one)
- **HM-213** SPEAKER-MICROPHONE

Full sized waterproof speaker-microphone including alligator type clip to attach to your shirt or collar, and so on.

The HM-213 meets IPX7 requirements for waterproof protection.

Approved Icom optional equipment is designed for optimal performance when used with an Icom transceiver. Icom is not responsible for the destruction or damage to an Icom transceiver in the event the Icom transceiver is used with equipment that is not manufactured or approved by Icom.

Some options may not be available in some countries. Please ask your dealer for details.



# 13 VHF MARINE CHANNEL LIST

## □ For IC-M25EURO (Except AUS)

### • International channels

CH	Frequency (MHz)		CH	Frequency (MHz)		CH	Frequency (MHz)		CH	Frequency (MHz)		CH	Frequency (MHz)		CH	Frequency (MHz)				
	Transmit	Receive		Transmit	Receive		Transmit	Receive		Transmit	Receive		Transmit	Receive		Transmit	Receive			
01	156.050	160.650	11	156.550	156.550	21	157.050	161.650	61	156.075	160.675	71	156.575	156.575	81	157.075	161.675	1019 <sup>*4</sup>	156.950	156.950
02	156.100	160.700	12	156.600	156.600	22	157.100	161.700	62	156.125	160.725	72	156.625	156.625	82	157.125	161.725	1020 <sup>*4</sup>	157.000	157.000
03	156.150	160.750	13	156.650	156.650	23	157.150	161.750	63	156.175	160.775	73	156.675	156.675	83	157.175	161.775	1078 <sup>*4</sup>	156.925	156.925
04	156.200	160.800	14	156.700	156.700	24	157.200	161.800	64	156.225	160.825	74	156.725	156.725	84	157.225	161.825	1079 <sup>*4</sup>	156.975	156.975
05	156.250	160.850	15 <sup>*1</sup>	156.750	156.750	25	157.250	161.850	65	156.275	160.875	75 <sup>*3</sup>	156.775	156.775	85	157.275	161.875	2019 <sup>*4</sup>	161.550	161.550
06	156.300	156.300	16	156.800	156.800	26	157.300	161.900	66	156.325	160.925	76 <sup>*3</sup>	156.825	156.825	86	157.325	161.925	2020 <sup>*4</sup>	161.600	161.600
07	156.350	160.950	17 <sup>*1</sup>	156.850	156.850	27	157.350	161.950	67	156.375	156.375	77	156.875	156.875	87	157.375	157.375	2078 <sup>*4</sup>	161.525	161.525
08	156.400	156.400	18	156.900	161.500	28	157.400	162.000	68	156.425	156.425	78	156.925	161.525	88	157.425	157.425	2079 <sup>*4</sup>	161.575	161.575
09	156.450	156.450	19	156.950	161.550	37A <sup>*2</sup>	157.850	157.850	69	156.475	156.475	79	156.975	161.575	P4 <sup>*2</sup>	161.425	161.425			
10	156.500	156.500	20	157.000	161.600	60	156.025	160.625	70	RX Only	156.525	80	157.025	161.625						

\*1 Channels 15 and 17 may also be used for on-board communications provided the effective radiated power does not exceed 1 W, and subject to the national regulations of the administration concerned when these channels are used in its territorial waters.

\*2 UK Marina Channels: M1=37A (157.850 MHz), M2=P4 (161.425 MHz) for only the UK version.

\*3 The output power of channels 75 and 76 are limited to low power (1 W) only. The use of these channels should be restricted to navigation-related communications only and all precautions should be taken to avoid harmful interference to channel 16, e.g. by means geographical separation.

\*4 For only the HOL version.



☐ For IC-M25EURO (Except AUS)

• USA channels

CH	Frequency (MHz)		CH	Frequency (MHz)		CH	Frequency (MHz)		CH	Frequency (MHz)		CH	Frequency (MHz)				
	Transmit	Receive		Transmit	Receive		Transmit	Receive		Transmit	Receive		Transmit	Receive			
01A	156.050	156.050	12	156.600	156.600	22A	157.100	157.100	64A	156.225	156.225	75*1	156.775	156.775	85	157.275	161.875
--	---	---	13*1	156.650	156.650	23A	157.150	157.150	65A	156.275	156.275	76*1	156.825	156.825	85A	157.275	157.275
03A	156.150	156.150	14	156.700	156.700	24	157.200	161.800	66A	156.325	156.325	77*1	156.875	156.875	86	157.325	161.925
--	---	---	15*1	156.750	156.750	25	157.250	161.850	67*1	156.375	156.375	78A	156.925	156.925	86A	157.325	157.325
05A	156.250	156.250	16	156.800	156.800	26	157.300	161.900	68	156.425	156.425	79A	156.975	156.975	87	157.375	161.975
06	156.300	156.300	17*1	156.850	156.850	27	157.350	161.950	69	156.475	156.475	80A	157.025	157.025	87A	157.375	157.375
07A	156.350	156.350	18A	156.900	156.900	28	157.400	162.000	70	RX Only	156.525	81A	157.075	157.075	88	157.425	162.025
08	156.400	156.400	19A	156.950	156.950	37A*2	157.850	157.850	71	156.575	156.575	82A	157.125	157.125	88A	157.425	157.425
09	156.450	156.450	20	157.000	161.600	61A	156.075	156.075	72	156.625	156.625	83A	157.175	157.175	P4*2	161.425	161.425
10	156.500	156.500	20A	157.000	157.000	--	---	---	73	156.675	156.675	84	157.225	161.825			
11	156.550	156.550	21A	157.050	157.050	63A	156.175	156.175	74	156.725	156.725	84A	157.225	157.225			

\*1 Low power only.

\*2 UK Marina Channels: M1=37A (157.850 MHz), M2=P4 (161.425 MHz) for only the UK version.

/// **NOTE:** Simplex channels, 3, 21, 23, 61, 64, 81, 82 and 83 **CANNOT** be lawfully used by the general public in USA waters.

# INDEX

<b>- A -</b>	
Accessories .....	2
Adjusting the volume level .....	10
Adjusting the squelch level .....	11
Antenna .....	2 and 30
AquaQuake water draining function .....	13
Alarm function .....	21
Alert function .....	9
ATIS code confirmation .....	26
ATIS code programming .....	26
Attachments .....	2 and 25
Auto scan function .....	19
AVERTISSEMENT POUR LES OPÉRATEURS RADIO .....	iv

<b>- B -</b>	
Backlight .....	20
Basic operation .....	8
Battery caution .....	22
Battery charge .....	3 and 23
Battery disposal .....	24
Battery lifetime .....	24
Battery replacement .....	24
Beep tone function .....	18
Belt clip .....	2 and 30

<b>- C -</b>	
Call channel (Selecting) .....	9
Call channel (Setting) .....	13
Channel 16 .....	9
Channel group .....	8
Channel selection .....	8
Charger .....	3, 23 and 30
Charging .....	3 and 23
Charging caution .....	23
Charging time .....	3
COUNTRY CODE LIST .....	vii

<b>- D -</b>	
Display .....	6 and 7
Distress .....	ii and 9
Dualwatch .....	16

<b>- E -</b>	
EXPLICIT DEFINITIONS .....	i

<b>- F -</b>	
FCC INFORMATION .....	vii
FEATURES .....	i
FOREWORD .....	i
Front, top and side panels .....	4
Function Display .....	6

<b>- H -</b>	
Handstrap .....	2
HM-213 .....	25 and 30

<b>- I -</b>	
IMPORTANT .....	i
IN CASE OF EMERGENCY .....	ii

<b>- L -</b>	
LCD contrast .....	20
Lock function .....	12

<b>- M -</b>	
VHF Marine channel list .....	31, 32 and 33
Monitor function .....	11
Monitor key action .....	19

- O -

Often-used channel ..... 13  
OPERATING RULES ..... 1  
SPEAKER-MICROPHONE..... 25 and 30  
OPTIONS ..... 30

- P -

Panel description ..... 4  
Power save function..... 20  
Power supply ..... 3 and 28  
PRECAUTIONS..... v  
Priorities ..... 1  
Priority scan..... 14 and 18  
Privacy..... 1

- R -

Radio licenses ..... 1  
RADIO OPERATOR WARNING ..... iii  
Receiving and transmitting ..... 10  
RECOMMENDATION ..... ii

- S -

Scan resume timer ..... 18  
Scan (Starting a scan)..... 15  
Scan types ..... 14  
Set mode ..... 17  
Set mode items..... 17-21  
Set mode operation ..... 17  
Setting Favorite channels ..... 15  
Specifications ..... 28  
Squelch..... 11  
Squelch level ..... 11

- T -

TABLE OF CONTENTS..... vi  
Time-out timer ..... 10  
Transmit power ..... 11 and 29  
Tri-watch ..... 16 and 19  
TROUBLESHOOTING..... 27

- V -

VHF MARINE CHANNEL LIST..... 31  
Volume level ..... 10 and 12

- W -

Weather alert function ..... 9 and 18  
Weather channels..... 9 and 31









**Count on us!**

**< Intended Country of Use >**

AT BE CY CZ DK EE  
FI FR DE GR HU IE  
IT LV LT LU MT NL  
PL PT SK SI ES SE  
GB IS LI NO CH BG  
RO TR HR

A-7227D-1EX  
Printed in Japan  
© 2015 Icom Inc.

Printed on recycled paper with soy ink.

**Icom Inc.**

1-1-32 Kamiminami, Hirano-ku, Osaka 547-0003, Japan